

IT EN FR ES D NL PL GR RUS

DOOR HINGE

# VENICE BABY

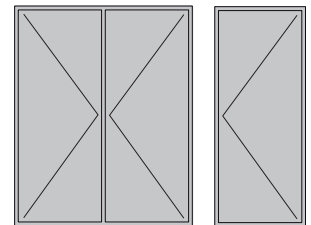
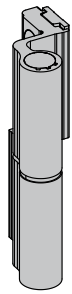

**CE** 05  
0497

009-DoP-CPR-2017  
EN 1935:2002 / AC:2003

3 7 4 0 1 4 0 1 1

**fapim**<sup>®</sup>  
Life in evolution

ULAL - Rev.01

**CE** 5603  
5603A  
5603C  
5613  
5633  
5643

~~**CE** 5603B  
5603T  
5603Q  
5603AT  
5613T  
5653~~

= Residential doors    
 = Public doors    
 + = Doors for public buildings with door closer without brake on opening    
 + = Doors for public buildings with door closer with brake on opening

**2 Hinges**

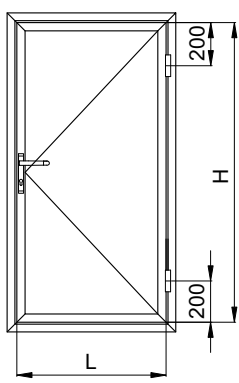

MAX 80 kg ~~5603Q~~

3000	80	80	80	80	80	80	80
2900	80	80	80	80	80	80	80
2800	80	80	80	80	80	80	80
2700	80	80	80	80	80	80	75
2600	80	80	80	80	80	80	69
2500	80	80	80	80	80	80	74
2400	80	80	80	80	80	80	68
2300	80	80	80	80	74	62	52
2200	80	80	80	80	67	56	46
2100	80	80	80	73	60	50	40
2000	80	80	80	66	54	44	35
≤800	900	1000	1100	1200	1300	1400	

L

**3 Hinges**

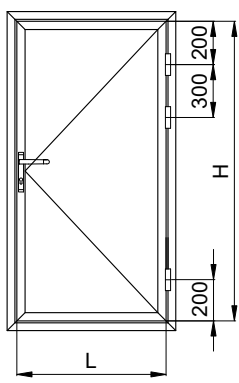

MAX 90 kg ~~5603Q~~

3000	90	90	90	90	90	90	90
2900	90	90	90	90	90	90	90
2800	90	90	90	90	90	90	90
2700	90	90	90	90	90	90	84
2600	90	90	90	90	90	90	78
2500	90	90	90	90	90	84	71
2400	90	90	90	90	90	77	65
2300	90	90	90	90	83	70	58
2200	90	90	90	90	75	63	52
2100	90	90	90	82	68	56	45
2000	90	90	90	74	60	49	39
≤800	900	1000	1100	1200	1300	1400	

L

**4 Hinges**

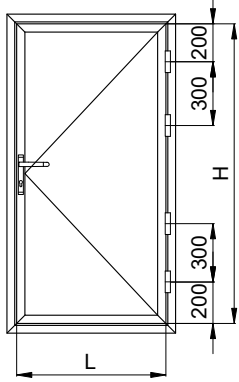

MAX 100 kg ~~5603Q~~

3000	100	100	100	100	100	100	100
2900	100	100	100	100	100	100	100
2800	100	100	100	100	100	100	100
2700	100	100	100	100	100	100	93
2600	100	100	100	100	100	100	86
2500	100	100	100	100	100	93	79
2400	100	100	100	100	100	85	72
2300	100	100	100	100	92	77	65
2200	100	100	100	100	84	70	58
2100	100	100	100	91	75	62	50
2000	100	100	100	82	67	54	43
≤800	900	1000	1100	1200	1300	1400	

L

= - 10Kg  
 + = - 20Kg  
 + = - 30Kg

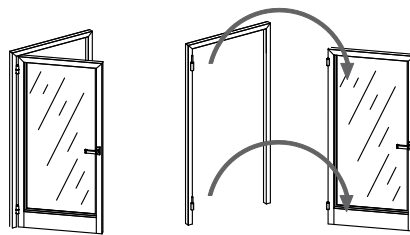
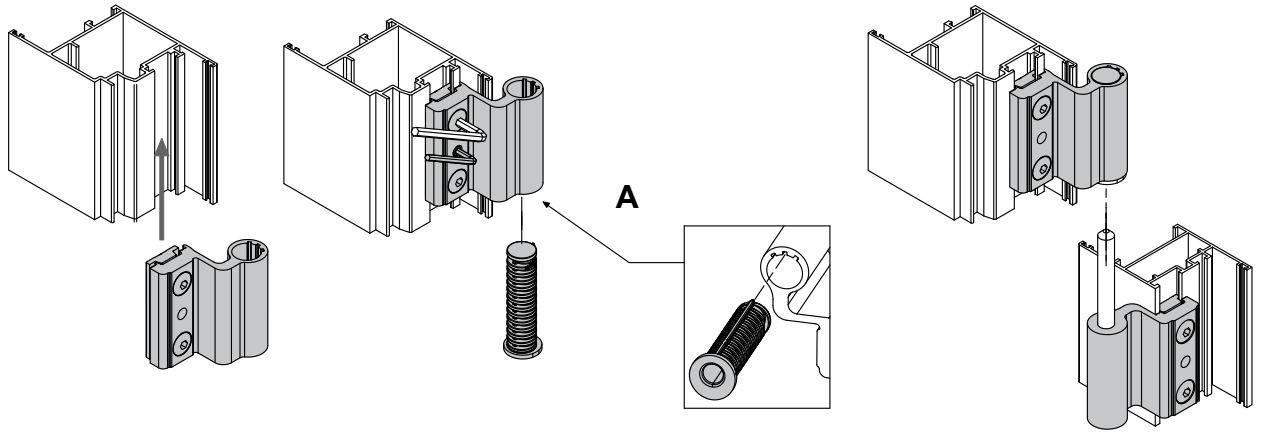
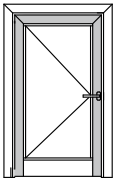
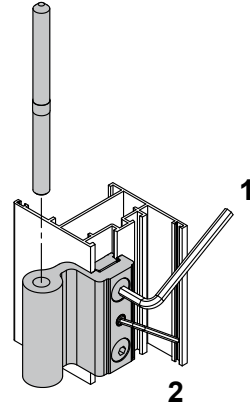
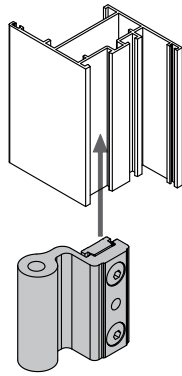
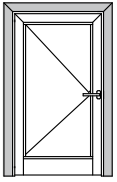

-1 mm      +1 mm

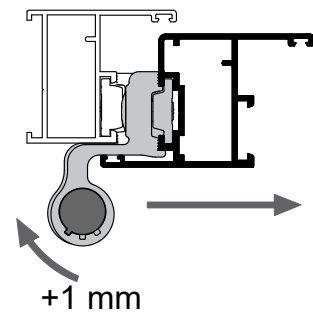
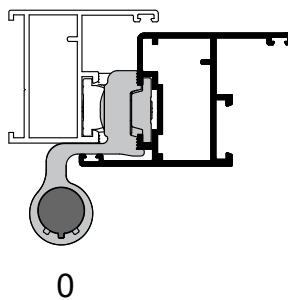
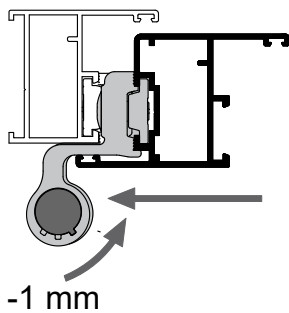



#### MANUTENZIONE

Lubrificare il perno ogni 25000 cicli o almeno ogni sei mesi con grasso che abbia una temperatura d'impiego adeguata alle condizioni di utilizzo.

#### MAINTENANCE

The pin has to be lubricated every 25000 cycles or 6 months at least with grease with temperature of use suitable to the working conditions.

#### ENTRETIEN

Graisser l'axe tous les 25000 cycles ou tout les 6 mois au moins par du gras qui ait une température d'utilisation apte aux conditions de utilise.

#### NSTANDHALTUNG

Den Zapfen mit Fett oder einem ähnlichen Produkt alle 25.000 Zyklen oder mindestens alle 6 Monate; das Fett soll eine Verwendungstemperatur haben, die für die Verwendungsbedingungen geeignet ist.

#### MANTENIMIENTO

Lubricar el eje cada 25.000 ciclos o cada por lo menos cada 6 meses con grasa que tenga una temperatura de uso adecuada a las condiciones de utilización.

#### MANUTENÇÃO.

Lubrifique o eixo a cada 25.000 ciclos ou pelo menos a cada seis meses com lubrificante que tenha uma temperatura de uso adequada às condições de uso.

#### ONDERHOUD

Smeer de pen elke 25000 cycli ofwel ten minste alle 6 maanden in met waarvan de gebruikstemperatuur geschikt is voor de omgevingstemperatuur.

#### KONSERWACJA

Natłuszczać bolec co 25000 cykli albo raz na 6 miesięcy lub też zakres temperatu-rowy dostosowany do warunków, w których użytkowany jest zawias.

#### ΣΥΝΤΗΡΗΣΗ

Γρασάρετε τον πείρο κάθε 25000 κύκλους χρησιμοποιή μήνες τουλάχιστον ή άλλο ισοδύναμο με θερμοκρασία χρήσης κατάλληλη για τις συνθήκες χρήσης.

#### ОБСЛУЖИВАНИЕ

Смазывайте ось каждые 25000 циклов или Каждые 6 месяцев или другой аналогичной смазкой, имеющей рабочие характеристики, соответствующие условиям использования.