

IT EN FR ES P D NL PL GR RUS

WINDOW HINGE

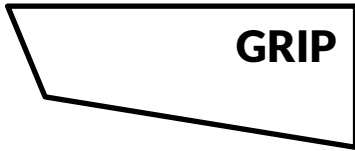

Art. 9826

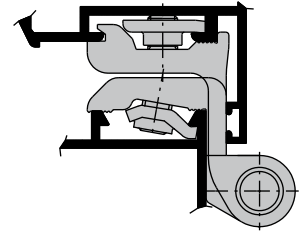
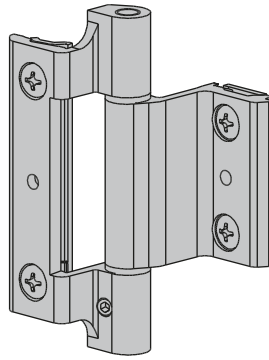

**fapim**<sup>®</sup>

Life in evolution

ULDL - Rev.00

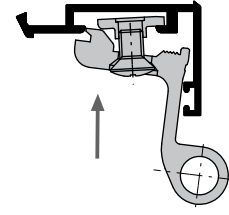
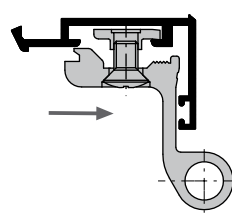
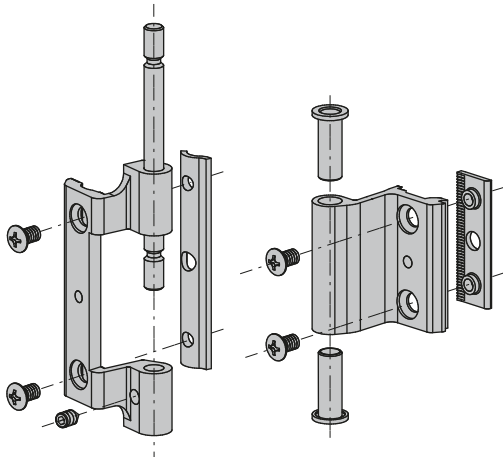

UNI EN ISO 4757 H 2 6Nm

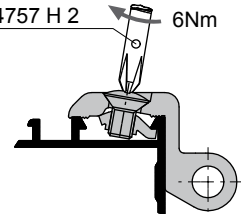
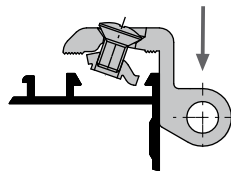

Limite d'impiego consigliato - Limit of use suggested - Limite d'utilisation conseillé - Empfohlenen Anwendungsgrenze - Limite de empleo aconsejado  
 Aanbevolen gebruikslimiet - Sugerowane ograniczenia zastosowania - Προτεινόμενο όριο χρήσης - Limite de uso empregado

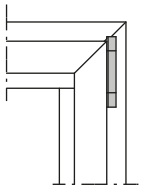
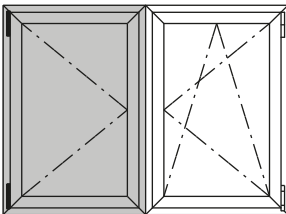

- Posizionamento cerniera
- Hinge positioning
- Positionnement paumelle
- Positionieren des Bands
- Posición de la bisagra
- Positionering van de scharnier
- Pozycjonowanie zawiasów
- θέση μεντεσε
- Posicionamento dobradiça

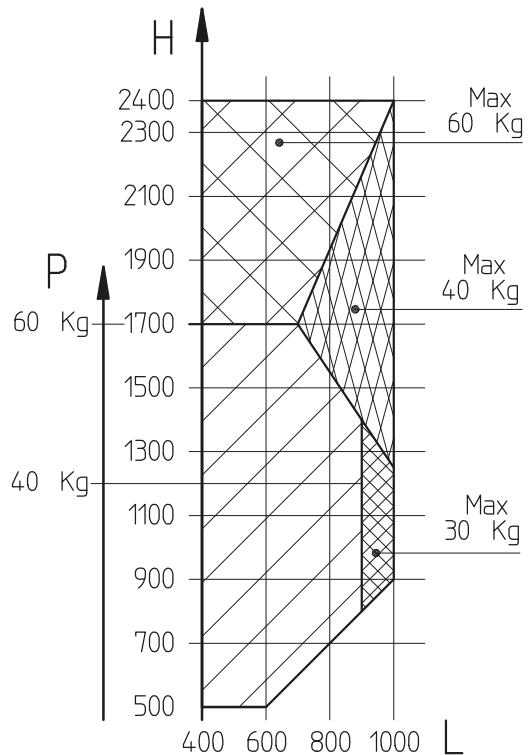

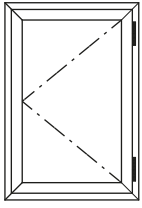

- n. 2 cerniere
- n. 2 Hinges
- n. 2 Paumelles
- n. 2 Bänder
- n. 2 Bisagras
- n. 2 Scharnieren
- n. 2 Zawiasy
- n. 2 Μεντεσεδες
- n. 2 Doibradiça

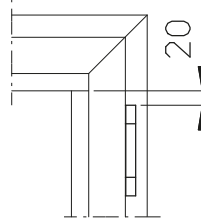

- Posizionamento cerniera
- Hinge positionning
- Positionnement paumelle
- Positionieren des Bands
- Posicion de la bisagra
- Positionering van de scharnier
- Pozycjonowanie zawiasów
- θεση μεντεσε
- Posicionamento dobradiça

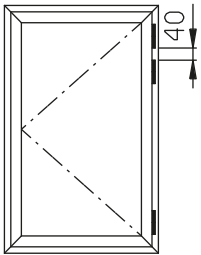

- n. 3 cerniere
- n. 3 Hinges
- n. 3 Paumelles
- n. 3 Bänder
- n. 3 Bisagras
- n. 3 Scharnieren
- n. 3 Zawiasy
- n. 3 Μεντεσεδες
- n. 3 Doibradiça

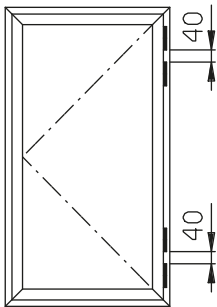

- n. 4 cerniere
- n. 4 Hinges
- n. 4 Paumelles
- n. 4 Bänder
- n. 4 Bisagras
- n. 4 Scharnieren
- n. 4 Zawiasy
- n. 4 Μεντεσεδες
- n. 4 Doibradiça

